

APD Series 8-150

Silicon Avalanche Photodiodes, 800nm band



FEATURES

- Low Bias Operation
- Low Temperature Coefficient: 0.45 V/°C
- High Sensitivity, Low Noise
- High Bandwidth

APPLICATIONS

- Optical Fiber Communication
- Laser range finder
- High speed photometry

GENERAL RATINGS / ABSOLUTE MAXIMUM RATINGS

Product Model	Active Area		Package Style*2	Storage Temperature (°C)		Operating Temperature (°C)	
	Diameter*1 (mm)	Area (mm ²)		Min	Max	Min	Max
APD02-8-150-xxxx	0.2	0.03	T52, T52L	-55	+125	-40	+100
APD05-8-150-xxxx	0.5	0.19		-55	+125	-40	+100
APD10-8-150-xxxx	1.0	0.78		-55	+125	-40	+100
APD15-8-150-xxxx	1.5	1.77	TO5, T5H, T5i	-55	+125	-40	+100
APD30-8-150-xxxx	3.0	7.0		-55	+125	-40	+100
APD50-8-150-xxxx	5.0	19.6	TO8, T8H	-55	+125	-40	+100

ELECTRO-OPTICAL CHARACTERISTICS (T_A = 23°C, typical values at gain listed, unless otherwise specified)

Product Model	Responsivity @ Gain M λ = 800 nm (A/W)	Dark Current Gain M (nA)		Ct Gain M (pF)	Q.E. M = 1 λ = 800 nm (%)	Breakdown Voltage 100uA (V)		Temperature Coefficient of Breakdown Voltage (V/°C)	Bandwidth -3dB Gain M λ = 800 nm (MHz)	Excess Noise Figure Gain M λ = 800 nm	Gain M λ = 800 nm
		Typ	Max			Typ	Max				
APD02-8-150-xxxx	50	0.05	1	1.5	75	150	250	0.45	1000	0.3	100
APD05-8-150-xxxx		0.1	1	3	75	150	250	0.45	900	0.3	100
APD10-8-150-xxxx		0.2	2	6	75	150	250	0.45	600	0.3	100
APD15-8-150-xxxx		0.5	5	10	75	150	250	0.45	350	0.3	100
APD30-8-150-xxxx	30	1	10	40	75	150	250	0.45	65	0.3	60
APD50-8-150-xxxx	20	3	30	105	75	150	250	0.45	25	0.3	40

*1: Area in which a typical gain can be obtained

*2: Please refer to mechanical outline section to choose desired TO can package options. Cap with micro-lens is available for small active area size.

APD Series 8-150

Silicon Avalanche Photodiodes, 800nm band

Typ. Spectral Response ($T_A = 23^\circ\text{C}$, $M = 100$)

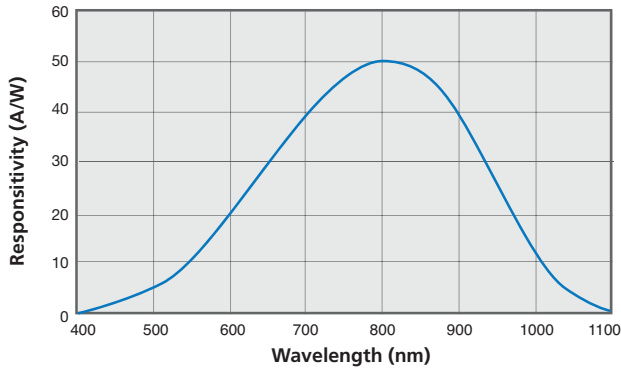

Typ. Quantum Efficiency vs. Wavelength ($T_A = 23^\circ\text{C}$)

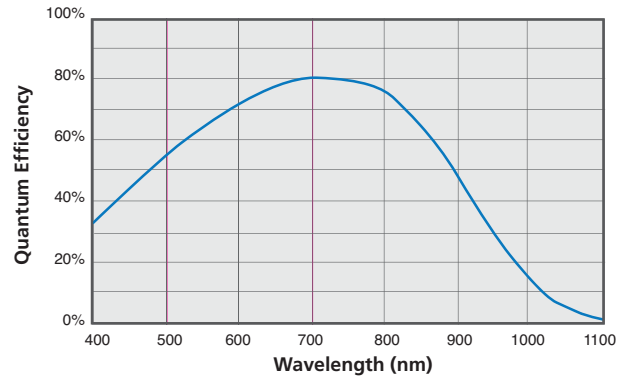

Typ. Dark Current vs. Reverse Bias ($T_A = 23^\circ\text{C}$)

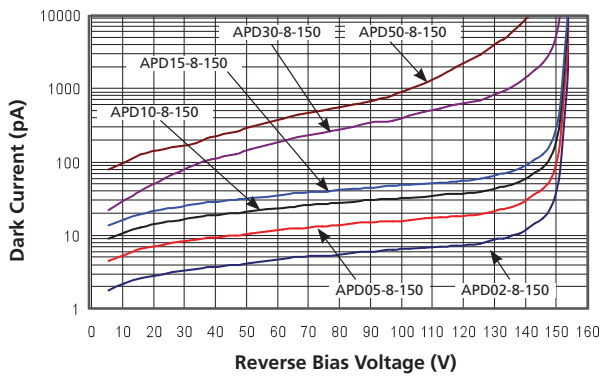

Typ. Gain vs. Reverse Bias ($T_A = 23^\circ\text{C}$, 800 nm)

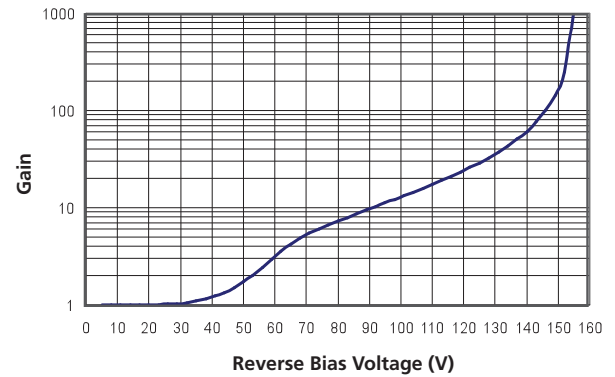

Typ. Capacitance vs. Reverse Bias ($T_A = 23^\circ\text{C}$, $f = 1\text{MHz}$)

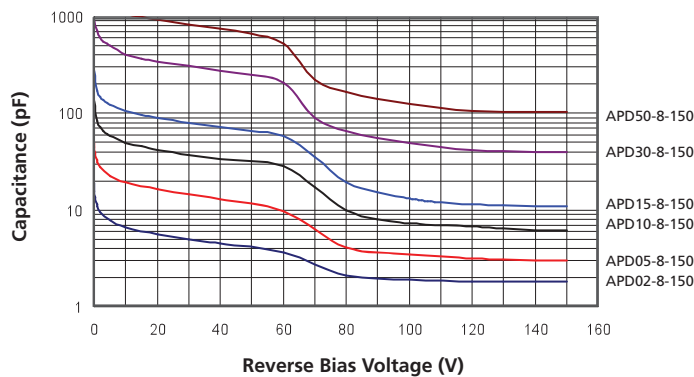

Mechanical Specifications

All units in mm. Pinouts are bottom view.

T52

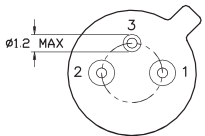
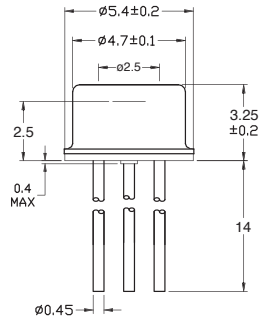

Pin Circle Dia = 2.54

	Products
Series 6-150	APD02-6-150-T52
	APD05-6-150-T52
	APD10-6-150-T52
Series 8-150	APD02-8-150-T52
	APD05-8-150-T52
	APD10-8-150-T52
Series 9-250	APD02-9-250-T52
	APD05-9-250-T52
	APD10-9-250-T52

Glass window may extend a maximum of 0.1 mm above the upper surface of the cap.

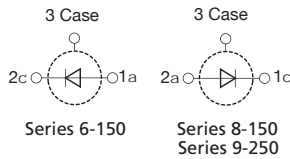

T52L (with lens)

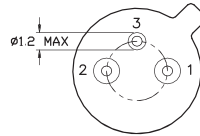
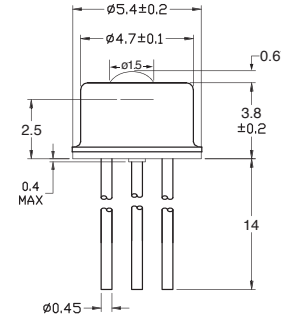

Pin Circle Dia = 2.54

	Products
Series 6-150	APD02-6-150-T52L
	APD05-6-150-T52L
Series 8-150	APD02-8-150-T52L
	APD05-8-150-T52L
Series 9-250	APD02-9-250-T52L
	APD05-9-250-T52L

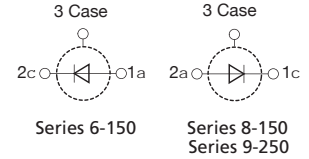

T46

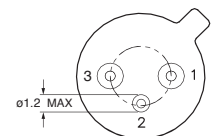
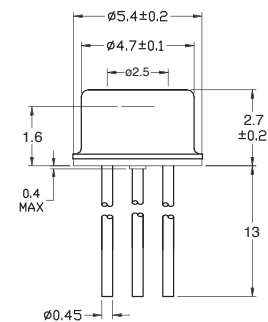

Pin Circle Dia = 2.54

	Products
Series 15-60	APD007-15-60-T46
	APD020-15-60-T46

Window is broadband A/R coated
Centered at 1300nm.

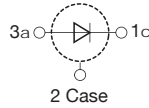

T46L (with lens)

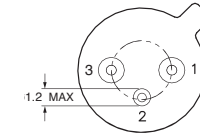
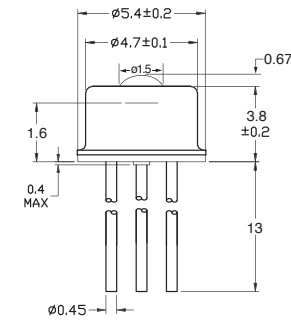

Pin Circle Dia = 2.54

	Products
Series 15-60	APD007-15-60-T46L
	APD020-15-60-T46L

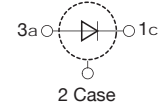

TO5

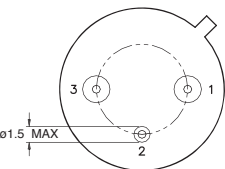
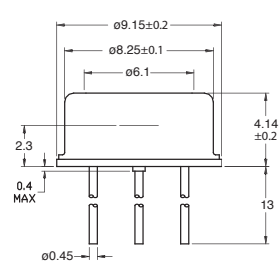

Pin Circle Dia = 5.08

	Products
Series 6-150	APD15-6-150-TO5
	APD30-6-150-TO5
Series 8-150	APD15-8-150-TO5
	APD30-8-150-TO5
Series 9-250	APD15-9-250-TO5

Glass window may extend a maximum of 0.2 mm above the upper surface of the cap.

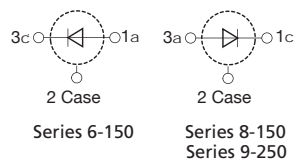

T5H

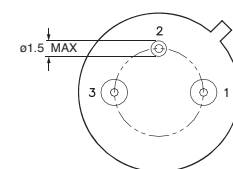
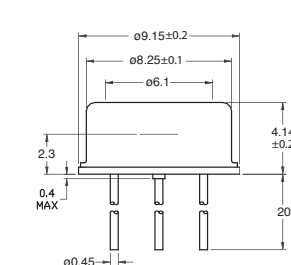

Pin Circle Dia = 5.08

	Products
Series 6-150	APD15-6-150-T5H
	APD30-6-150-T5H
Series 8-150	APD15-8-150-T5H
	APD30-8-150-T5H
Series 9-250	APD15-9-250-T5H

Glass window may extend a maximum of 0.2 mm above the upper surface of the cap.

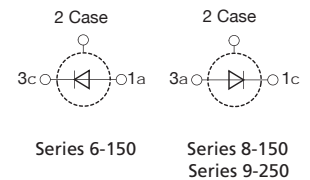

Mechanical Specifications

All units in mm. Pinouts are bottom view.

T5i

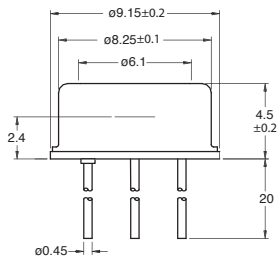

	Products
Series 6-150	APD15-6-150-T5i
	APD30-6-150-T5i
Series 8-150	APD15-8-150-T5i
	APD30-8-150-T5i
Series 9-250	APD15-9-250-T5i

Glass window may extend a maximum of 0.2 mm above the upper surface of the cap.

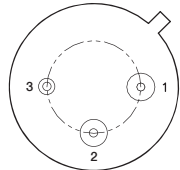

Pin Circle Dia = 5.08

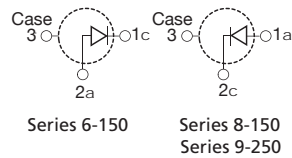

TO8

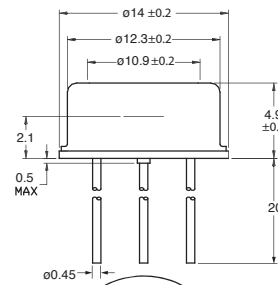

	Products
Series 6-150	APD50-6-150-TO8
Series 8-150	APD50-8-150-TO8

Glass window may extend a maximum of 0.2 mm above the upper surface of the cap.

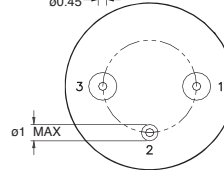

Pin Circle Dia = 7.5

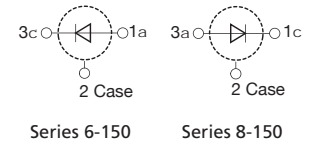

T8H

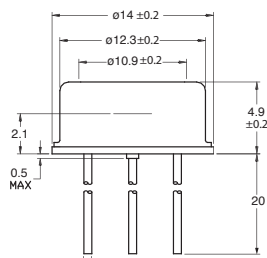

	Products
Series 6-150	APD50-6-150-T8H
Series 8-150	APD50-8-150-T8H

Glass window may extend a maximum of 0.2 mm above the upper surface of the cap.

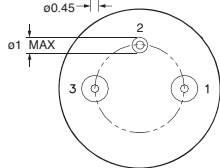

Pin Circle Dia = 7.5

