

Dual Sandwich Detector Series

Two Color Photodiodes

Dual Sandwich Detectors or **Two Color Detectors** are mostly employed for remote temperature measurements. The temperature is measured by taking the ratio of radiation intensities of two adjacent wavelengths and comparing them with the standard black body radiation curves. The advantages of optical remote measurement have definitely made these devices the perfect match for this type of measurements. They are independent of emissivity and unaffected by contaminants in the field of view or moving targets. In addition, measurements of targets out of the direct line of sight and the ability to function from outside RF/EMI interference or vacuum areas are possible. They also have the advantages of overcoming obstructed target views, blockages from sight tubes, channels or screens, atmospheric smoke, steam, or dust, dirty windows as well as targets smaller than field of view and/or moving within the field of view. These detectors can also be used in applications where wide wavelength range of detection is needed.

OSI Optoelectronics offers three types of dual sandwich detectors. The Silicon-Silicon sandwich, in which one silicon photodiode is placed on top of the other, with the photons of shorter wavelengths absorbed in the top silicon and the photons of longer wavelengths penetrating deeper, absorbed by the bottom photodiode. For applications requiring a wider range of wavelength beyond 1.1 μm , an InGaAs photodiode replaces the bottom photodiode. The Silicon-InGaAs version is also available with a two stage thermo-electric cooler for more accurate measurements by stabilizing the temperature of the InGaAs detector.

All devices are designed for photovoltaic operation (no bias), however, they may be biased if needed, to the maximum reverse voltage specified. They are ideal for coupling to an operational amplifier in the current mode. For further details refer to the "Photodiode Characteristics" section of this catalog.

APPLICATIONS

- Flame Temperature sensing
- Spectrophotometer
- Dual-wavelength detection
- IR Thermometers for Heat Treating, induction heating, and other metal parts processing

FEATURES

- Compact
- Hermetically Sealed
- Low Noise
- Wide Wavelength Range
- Remote Measurements
- w/ TEC

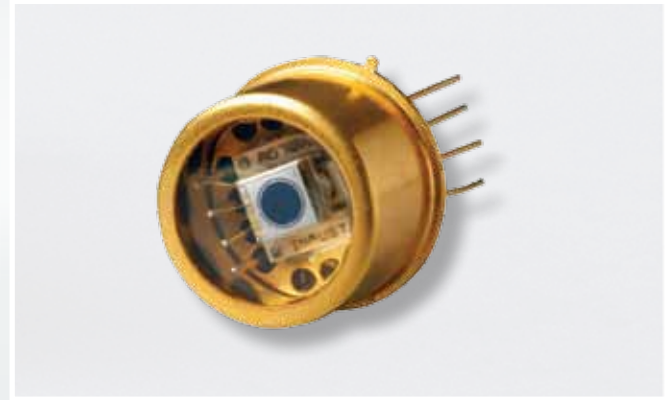

Typical Spectral Response

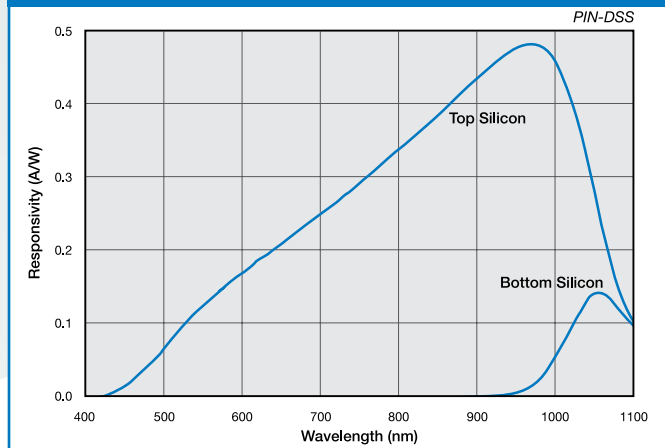

Typical Spectral Response

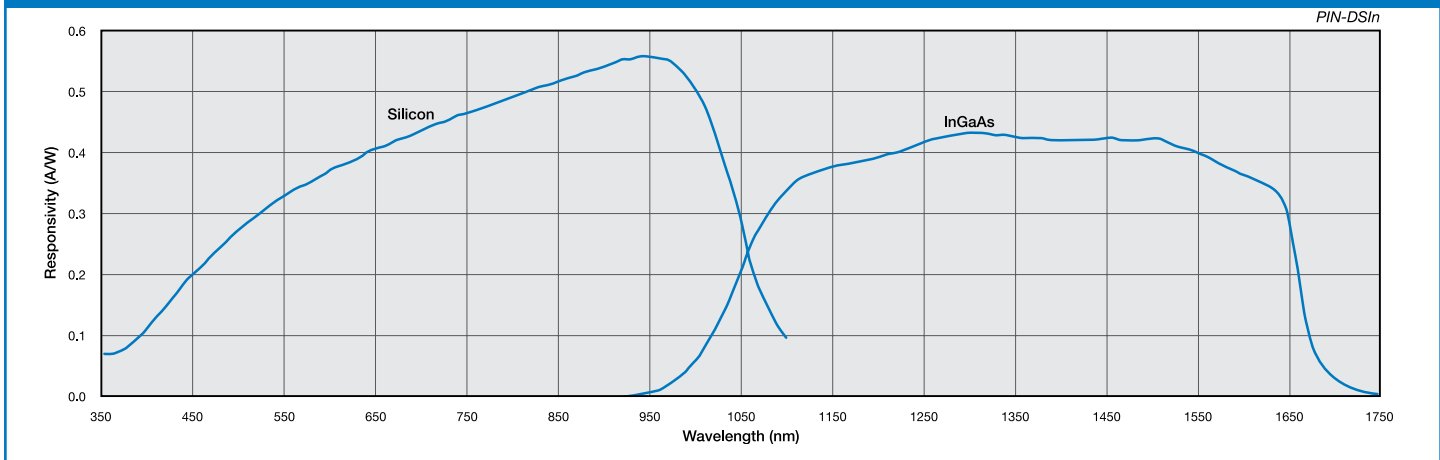

AVOID DIRECT LIGHT

Since the spectral response of silicon photodiode includes the visible light region, care must be taken to avoid photodiode exposure to high ambient light levels, particularly from tungsten sources or sunlight. During shipment from OSI Optoelectronics, your photodiodes are packaged in opaque, padded containers to avoid ambient light exposure and damage due to shock from dropping or jarring.

AVOID SHARP PHYSICAL SHOCK

Photodiodes can be rendered inoperable if dropped or sharply jarred. The wire bonds are delicate and can become separated from the photodiode's bonding pads when the detector is dropped or otherwise receives a sharp physical blow.

CLEAN WINDOWS WITH OPTICAL GRADE CLOTH / TISSUE

Most windows on OSI Optoelectronics photodiodes are either silicon or quartz. They should be cleaned with isopropyl alcohol and a soft (optical grade) pad.

OBSERVE STORAGE TEMPERATURES AND HUMIDITY LEVELS

Photodiode exposure to extreme high or low storage temperatures can affect the subsequent performance of a silicon photodiode. Storage temperature guidelines are presented in the photodiode performance specifications of this catalog. Please maintain a non-condensing environment for optimum performance and lifetime.

OBSERVE ELECTROSTATIC DISCHARGE (ESD) PRECAUTIONS

OSI Optoelectronics photodiodes, especially with IC devices (e.g. Photops) are considered ESD sensitive. The photodiodes are shipped in ESD protective packaging. When unpacking and using these products, anti-ESD precautions should be observed.

DO NOT EXPOSE PHOTODIODES TO HARSH CHEMICALS

Photodiode packages and/or operation may be impaired if exposed to CHLOROTHENE, THINNER, ACETONE, or TRICHLOROETHYLENE.

INSTALL WITH CARE

Most photodiodes in this catalog are provided with wire or pin leads for installation in circuit boards or sockets. Observe the soldering temperatures and conditions specified below:

Soldering Iron:	Soldering 30 W or less Temperature at tip of iron 300°C or lower.
Dip Soldering:	Bath Temperature: 260±5°C. Immersion Time: within 5 Sec. Soldering Time: within 3 Sec.
Vapor Phase Soldering:	DO NOT USE
Reflow Soldering:	DO NOT USE

Photodiodes in plastic packages should be given special care. Clear plastic packages are more sensitive to environmental stress than those of black plastic. Storing devices in high humidity can present problems when soldering. Since the rapid heating during soldering stresses the wire bonds and can cause wire to bonding pad separation, it is recommended that devices in plastic packages to be baked for 24 hours at 85°C.

The leads on the photodiode **SHOULD NOT BE FORMED**. If your application requires lead spacing modification, please contact OSI Optoelectronics Applications group at (310)978-0516 before forming a product's leads. Product warranties could be voided.



*Most of our standard catalog products are RoHS Compliant. Please contact us for details

Mechanical Drawings

Mechanical Specifications and Die Topography

1. Parameter Definitions:

A = Distance from top of chip to top of glass.

a = Photodiode Anode.

B = Distance from top of glass to bottom of case.

c = Photodiode Cathode

(Note: cathode is common to case in metal package products unless otherwise noted).

W = Window Diameter.

F.O.V. = Filed of View (see definition below).

2. Dimensions are in inches (1 inch = 25.4 mm).

3. Pin diameters are 0.018 ± 0.002 " unless otherwise specified.

4. Tolerances (unless otherwise noted)

General: $0.XX \pm 0.01$ "

$0.XXX \pm 0.005$ "

Chip Centering: ± 0.010 "

Dimension 'A': ± 0.015 "

5. Windows

All '**UV**' Enhanced products are provided with QUARTZ glass windows, 0.027 ± 0.002 " thick.

All '**XUV**' products are provided with removable windows.

All '**DLS**' PSD products are provided with A/R coated glass windows.

All '**FIL**' photoconductive and photovoltaic products are epoxy filled instead of glass windows.



$$F.O.V. = \tan^{-1} \left(\frac{W}{2A} \right)$$

For Further Assistance
Please Call One of Our Experienced
Sales and Applications Engineers

310-978-0516

OSI Optoelectronics
An OSI Systems Company

- Or -

visit our website at

www.osioptoelectronics.com

Mechanical Specifications

All units in inches. Pinouts are bottom view.

16 TO-18 Lensed Cap

Products:

PIN-HR005L
PIN-HR008L
PIN-HR020L
PIN-HR026L
PIN-HR040L

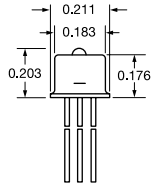

Pin Circle Dia.=0.100

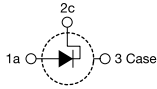

17 TO-5

Products:

PIN-DSS
PIN-DSIn

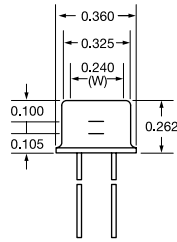

Pin Circle Dia.=0.220

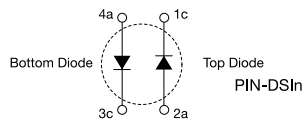
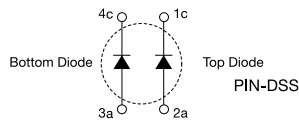

18 TO-5

Products:

PIN-005D-245F

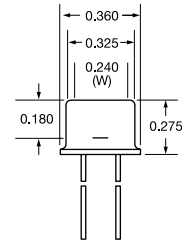

Pin Circle Dia.=0.215

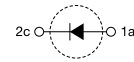

19 Plastic Mold

Products:

BPW34
BPW34B
BPW34S

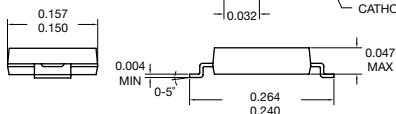
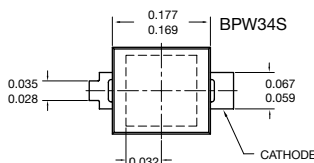
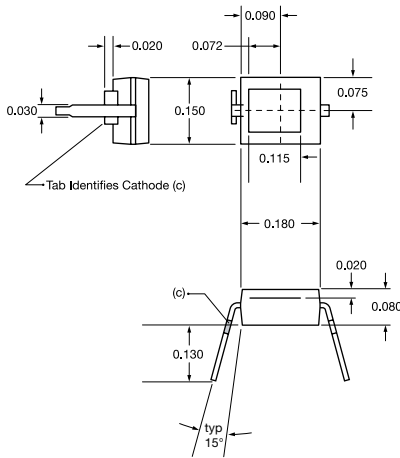

20 Special Metal

Products:

SPOT-15-YAG
SPOT-9-YAG
PIN-100-YAG

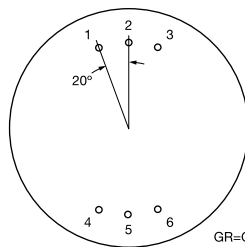
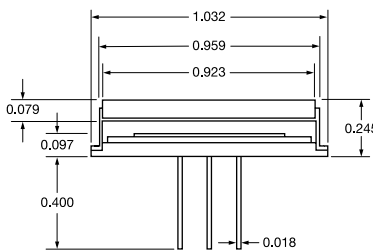

Pin Circle Dia.=0.750

GR=Guard Ring

Pinouts

P/N	1	2	3	4	5	6
SPOT-15-YAG	C1	GR	C4	C2	A	C3
SPOT-9-YAG	C1	GR	C4	C2	A	C3
PIN-100-YAG	--	C	--	--	A	--

21 Special Metal

Products:

SC-50D

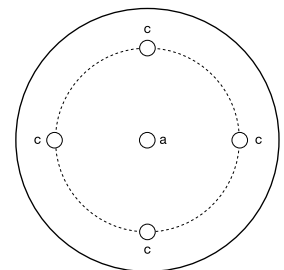
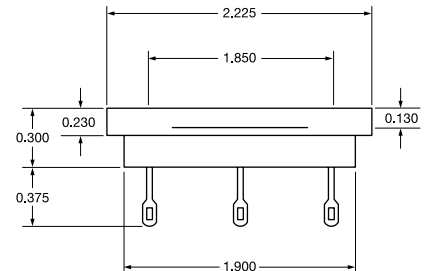

Pin Circle Dia.=1.110

Mechanical Specifications

All units in inches. Pinouts are bottom view.

22 TO-5

Products:

XUV-005

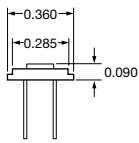

Pin Circle Dia.=0.200



23 TO-8

Products:

XUV-020
XUV-035

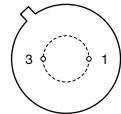
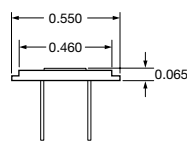

Pin Circle Dia.=0.295

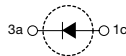

24 TO-8

Products:

PIN-DSIn-TEC

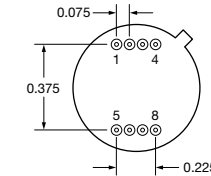
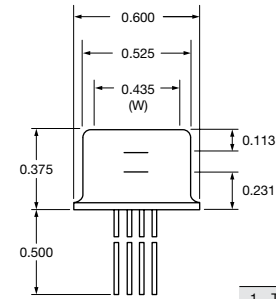

Pinout	
1	TEC (-)
2	Thermistor
3	Thermistor
4	TEC (+)
5	Top Silicon, Cathode
6	Top Silicon, Anode
7	Bottom InGaAs, Anode
8	Bottom InGaAs, Cathode

25 Special Ceramic / Plastic

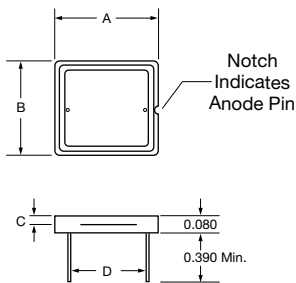

Dimensions

P/N	A	B	C	D
UV-005EQC	0.300	0.236	0.024	0.177
UV-035EQC	0.400	0.350	0.028	0.290
UV-100EQC	0.650	0.590	0.028	0.490
UV-005DQC	0.300	0.236	0.035	0.177
UV-035DQC	0.400	0.350	0.039	0.290
UV-100DQC	0.650	0.590	0.039	0.490
XUV-50C	0.650	0.590	0.027	0.490
XUV-100C	0.650	0.590	0.027	0.490
RD-100	0.650	0.590	0.027	0.490
RD-100A	0.650	0.590	0.027	0.490
UV-35P	0.390	0.345	0.050	0.275
OSD35-LR-A	0.390	0.350	---	0.290
OSD35-LR-D	0.390	0.350	---	0.290

Note: OSD35-prefix packages come with 0.31" (min.) leads

26 TO-8

Products:

RD-100
RD-100A
UV-35P
UV-005EQC
UV-035EQC
UV-100EQC
UV-005DQC
UV-035DQC
UV-100DQC
XUV-50C
XUV-100C
OSD35-LR-A
OSD35-LR-D

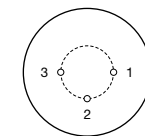
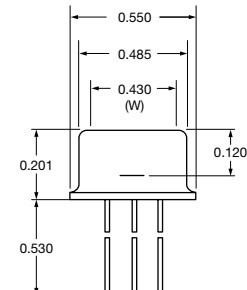

Pin Circle Dia.=0.295

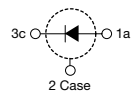

27 Special Plastic

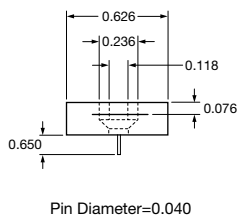
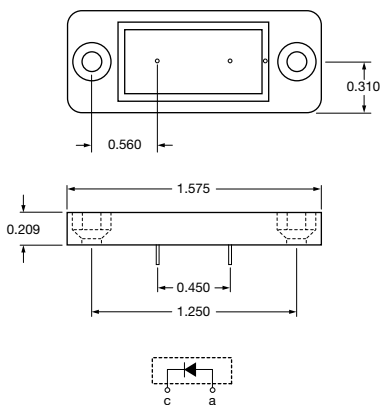

Pin Diameter=0.040



28 BNC

Products:

PIN-220D
PIN-220DP
PIN-220DP/SB

Products:

XUV-100

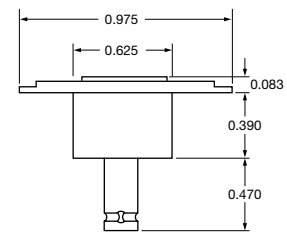

BNC Connector
Outer Contact = Cathode